

# HEWLETT-PACKARD JOURNAL

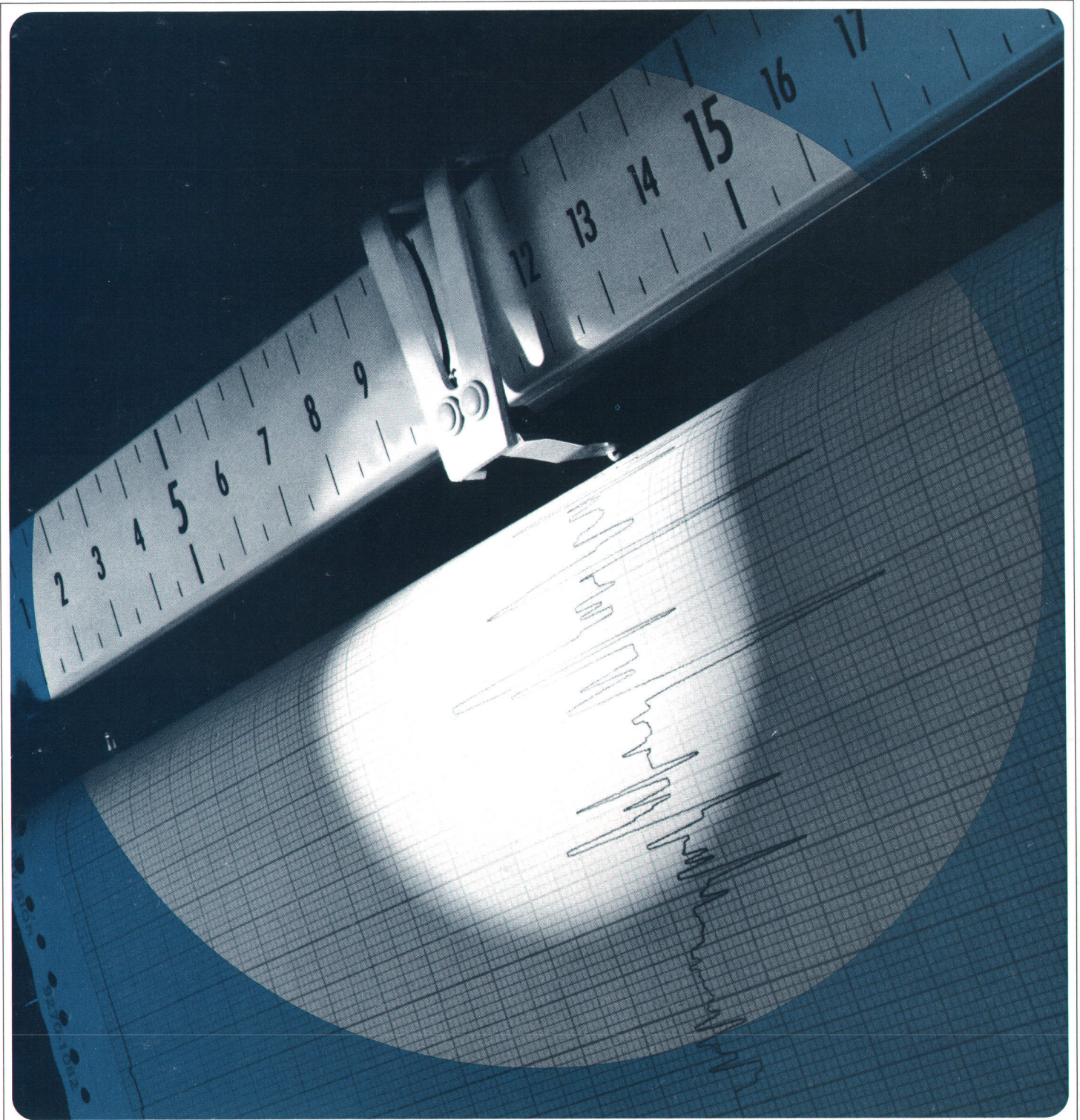

OCTOBER 1968

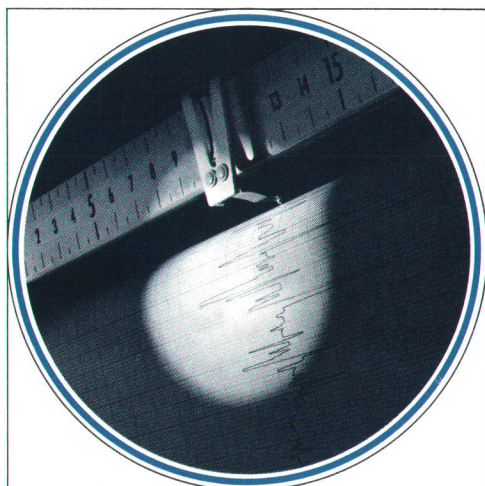

# Graphic Recorder Writing Systems

*Pen and ink has been the most widely used writing method, but a new low-voltage electric writing system has proven successful for many difficult applications.*

**By Dale R. Davis and Charles K. Michener**

CHOICE OF THE PROPER WRITING TECHNIQUE for graphic recording is largely a function of the content of the record and how the record is to be used. Since no single recording method can claim all of the advantages of all writing methods and none of their disadvantages, the choice of a writing technique becomes a compromise.

Some basic questions to be answered when selecting a system are: Is maintenance of the system simple? How often is it necessary to maintain the system? Is the system designed so that the line is uniform at the highest and lowest writing rates? Is the system reliable enough to do

**Cover:** Spring-mounted stylus used on HP electric writing recorders. This unique design prevents welding of the ball to the chart backing at very slow speeds.

**In this Issue:** Graphic Recorder Writing Systems; **page 2.** Recording True-rms Voltages Over Wide Dynamic Ranges; **page 9.** Atomic Hydrogen Masers; **page 15.**

the job the way it needs to be done? Is the record permanent, clean, high contrast, and smudge free? Will the record be marked by casual handling? Can the recorder be idled for long periods without a great deal of pre-start-up maintenance? Does the writing technique impose any special environmental limitation on the recorder such as temperature, humidity, RFI, altitude, or attitude? Are powders, gases, or liquid by-products generated during writing that may interfere with other gear in the area the recorder is used? Answers to these questions will help determine whether a specific writing method might be successful for a given application.

## **Ink Systems**

Among the many schemes for marking chart paper, the ink system has been most widely used. Its principal advantage is its ability to write in a variety of colors with high contrast. Several parameters may be recorded on the same chart, each in a different color, making identification easy. The chart paper is relatively inexpensive. An operator may become familiar with its operation and care without a great deal of special training.

**Capillary System.** A capillary system, Fig. 1 (left), consists of an ink reservoir, a piece of tubing leading from the reservoir to a metal pen tip and the paper on which the recording is made. Ink is pumped through the tubing to the pen tip prior to starting a record. After this initial 'priming' the ink continues to feed itself to the pen tip on demand by capillary action. The surface tension and viscosity of the ink is such that the movement of the pen tip on the graph paper pulls the ink from the pen tip. Since the pulling force is a function of stylus speed a relatively uniform line can be made over a broad range of writing speeds.

Where both high and low writing speeds (dynamic range) are necessary, the use of an ink with a low enough viscosity to flow and make a continuous line at high writing rates would not be satisfactory at low writing rates. The ink may run out of the pen and flood the paper. Inks designed to dry fast enough so they do not smudge by the time the user is ready to handle the record generally dry in the pen tip after being inoperative a few minutes to a few days. It is not uncommon to find water based inks still in use in capillary pen systems. A coffee spill on a record of this type can destroy the record. Further, a noisy signal can flood the chart paper with ink so that the chart paper becomes soggy and finally torn by the action of the stylus. A record made with a water based ink can be smudged by moisture even months after the record is made.

It is necessary to choose the proper diameter pen tip for the speed range desired. A typical range is from 10 inches per hour to 50 inches per second. A fine-tip pen can be used at speeds as low as 1/2 inch per hour, but then its upper limit is reduced.

A non-pressure system is subject to vapor lock caused by high temperatures, altitude or vibration. The ink used in these systems freezes at 0°C, and starts to bubble at 40°C, and eventually results in vapor lock. Vibration causes the ink to foam, forming bubbles that cause vapor lock.

In spite of the above problems capillary writing is still a very popular method of recording because of the ease of identifying traces and high contrast. Newer recorders have simplified inking, pen tip cleaning, and inks that minimize flooding and smudging.

**Pressurized Systems.** In recent years pressurized ink writing systems have been introduced by at least two firms. By modulating the pressure on the ink as the pen speed varies, it is possible to achieve very uniform, good contrast lines.

The writing systems have been engineered to require a minimum of pre-start-up maintenance, and to operate without the mess ordinarily associated with ink. A special coating on the paper used in these systems causes the non-water based inks to dry on contact and enables the pen to make a liquid seal with the paper to prevent ink drying.

**Ball Point and Fiber Tips.** Other methods of ink recording are also in use. Ball point tips can be used in place of the capillary tip. A compromise between the pressure on the tip and line width is necessary. Very tight mechanical tolerances are required for fine lines, but the pen will have a tendency to skip at higher speeds. Dynamic range is lower than a capillary ink system.

Fiber tipped pens contain a parallel bundle of fibers

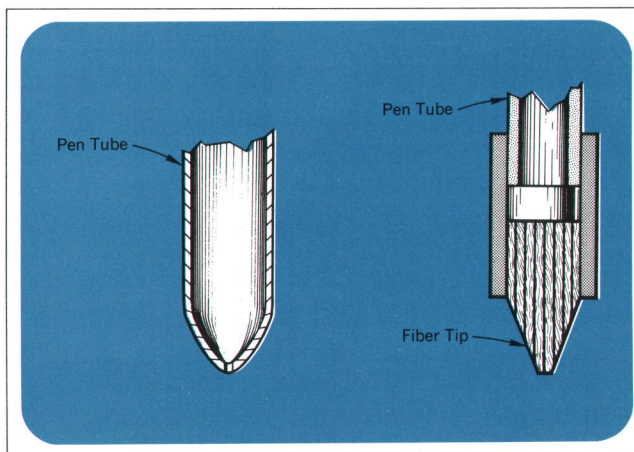

Fig. 1. General-purpose capillary pen tips (left) are steel tubes with an inside diameter of about 0.01-inch. Fiber pen tips (right) consist of a parallel bundle of fibers to reduce clogging. They are designed to be disposable and are easily replaced.

which provide many ink passages, Fig. 1 (right). Thus the pens do not clog as readily as the single-tube capillary tips. But as fiber tips wear, they tend to write broader lines and lose resolution. Fiber tips are designed to be disposable and easily replaced.

### Electric Writing Systems

**Electrosensitive Papers.** A relatively new electrosensitive paper is based upon the reduction of zinc oxide to free zinc. Conductive zinc oxide dispersed in an organic binder is coated onto a metal base such as aluminum foil that has been laminated to paper, Fig. 2. The passage of current through this coating reduces the zinc oxide in the layer, thereby forming the mark. The mark is in the coating, unlike other electrosensitive systems where the mark

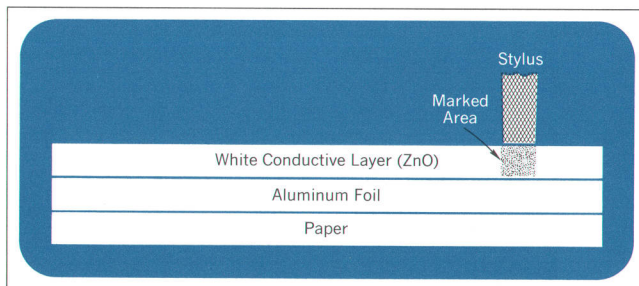

Fig. 2. New electrosensitive paper used in HP electric writing recorders. The current reduces the ZnO in the white coating to Zn which is dark brown.

is the result of erupting the coating from its base and exposing a black sheet. To prevent carbonization of the coating materials, the coating is designed so that its resistance increases when the mark is made. Both very high and very low writing speeds are possible without degradation of the mark. As a consequence the writing process is clean and dry, Fig. 3.

Writing rates as high as 200 in/s and as low as 1/2 in/hour are practical with some papers of this type. These papers are particularly useful in those applications where a permanent, rugged copy is required, where record cleanliness is important, and in those areas where rapid start up and reliability are of importance. The paper cannot be marked by pressure, heat, light or moisture. The marks are smudge resistant and reasonably contrasting.

Some RFI is generated during marking, but good instrument design reduces the radiation to a level low enough that interference with other equipment is not a problem. Some odor is generated during marking that is detectable when writing at higher speeds. The vapors given off during writing are non-toxic.

**Carbon-Impregnated Paper.** Perhaps the oldest type of electrosensitive paper, and still the most common, involves the removal of a thin light colored layer from a carbon impregnated paper by dielectric breakdown and subsequent eruption of the layer from the carbon filled paper, Fig. 4(a).

These papers have some electrical characteristics that make them less attractive than some of the other methods of recording. The resistance of the marked area is lowered after marking, so that marks made at low writing rates will either broaden out and over burn (image spreading), or very little marking will take place when the stylus is moving at high speed. Carbon is blown from the coating during marking leaving a residue on the paper and in the machine. RFI is a problem and can interfere with nearby equipment if the recorder is not properly shielded.

In addition to the above electrical problem, these papers are generally easy to mark with casual handling, due either to moisture on the users' hands or to the pressure sensitivity of the electrosensitive coating. An odor is generated during writing that increases as the amount of marking increases. Recent improvements in the conductivity of white pigments have made it possible to mark papers of this type at voltages compatible with current solid state circuitry.

**Electrolytic Papers.** In this system, the stylus material is gradually plated onto the surface of a conductive paper. The paper is saturated with a salt solution to make the paper conductive, Fig. 4(b). Reasonably low voltages (voltages as low as a fraction of a volt to 100 volts depending upon writing rate) are used in plating the paper. Excellent contrast and writing rates can be achieved with the system. The principal disadvantage of this type of writing is the requirement of having to keep the paper wet during use, and then having to dry it before handling.

Problems typical of those of handling corrosive chem-

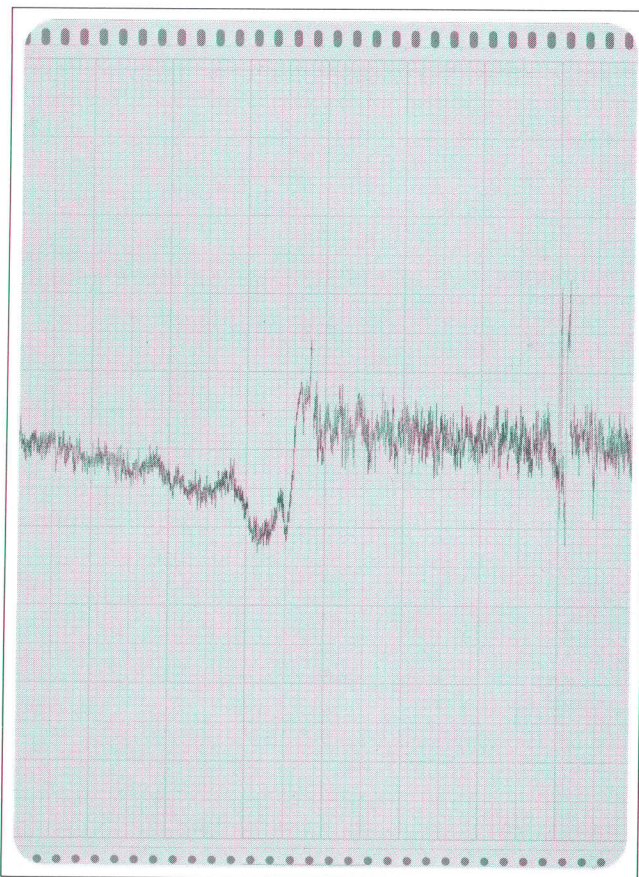

Fig. 3. Typical record from a 10-inch electric writing instrument recorded at 1-inch per hour shows excellent traces even with noisy input signals.

icals around electronic equipment must also be considered.

This system has been used for facsimile transmission of news photographs over telephone lines. Because of the short time the paper is in the facsimile recorder, it does not have time to dry out.

**Metallized Papers.** Probably the simplest method of electrical graphic recording is based upon the fusing of a vacuum-deposited metal on a paper or film base, Fig. 4(c). Exposing the paper base through the metal film produces the contrast necessary for viewing the mark. Marks can be made on these papers with as little as 1½ volts.

Problems encountered in this system include low contrast, paper corrosion at high humidities, and a possibility of eye fatigue due to the metallic appearance of the paper.

**Electrostatic Writing.** Electrostatic writing involves the use of a conductive paper with a dielectric coating on it. The dielectric coating is charged electrostatically in the areas to be marked. The charge is then held on the surface of the dielectric until the paper can be dusted with an electroscopic powder (toner) or bathed in a dielectric fluid containing charged particles. The toner makes the charged area visible, and the mark is made permanent by heating the toner and melting it to the dielectric coating, or by evaporating the dielectric fluid from around the particles and dry setting the particles to the surface of the paper.

Excellent black on white lines can be made by this system over a broad range of marking speeds. The system is particularly suited to those applications where chart speeds in excess of 10 in/min are used or where it is not necessary to view the record immediately as it is being made. Signals up to 5 kHz may be recorded.

Approximately 2 inches of record is inside the machine being developed before it is viewable. Very low speeds such as 1 in/hour do not seem practical.

#### Pressure Sensitive Systems

Pressure sensitive systems use a stylus that is pressed against a special paper to make a mark. A typical pressure sensitive paper of this type is made by coating a black paper base with microscopic spherical wax beads. When these beads are pressed, they flow and become transparent exposing the black base beneath the wax. Although this system alleviates many problems associated with ink, there are new problems that sometimes make it unsuitable. The paper can be marked by handling. Some of these papers mark not only from pressure, but also from moisture. If papers of this type are made so they do not mark easily in handling, high mechanical pressure

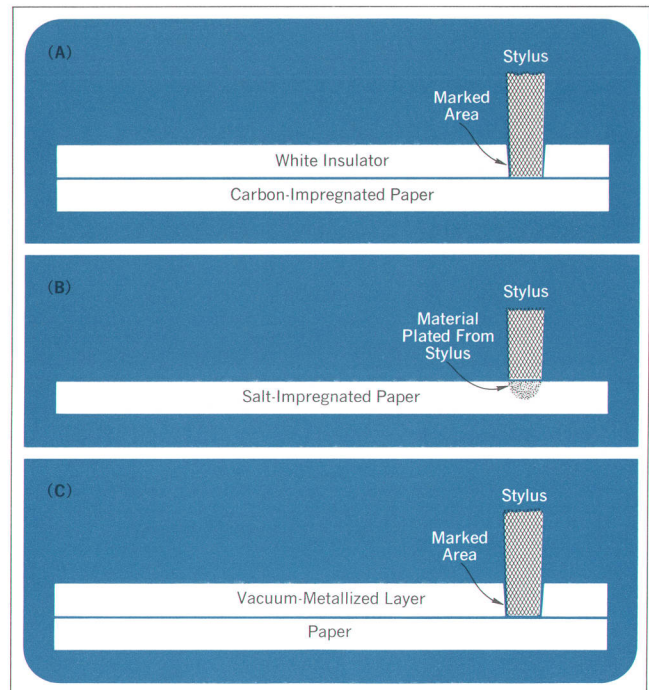

Fig. 4. Carbon-impregnated paper (top) is marked by raising the stylus voltage across the coating to the point of dielectric breakdown, removing the white insulating layer. The salt-impregnated paper (middle) is marked by electroplating stylus material onto the surface of the paper. Vacuum metallized papers (bottom) are marked by fusing away the metallized layer.

must be used on the stylus which could result in a less reliable writing mechanism.

Pressure sensitive papers are best suited to low speed recording where unattended operation is of prime importance and where the record is not usually handled nor intended to be a permanent record. These recorders are generally inexpensive.

#### Heat Sensitive Papers

Probably the most common heat sensitive writing method used in graphic recording uses a heated stylus which melts a thin white wax-like coating on a black paper base. The preparation of this type of paper is almost identical to the preparation of a waxed pressure-sensitive paper except that the wax-like spheres are made of a harder, less pressure-sensitive material that melts at low temperature. This type of system circumvents many of the problems inherent with both ink and pressure sensitive papers. The stylus system is quite reliable and high contrast traces are easily made. The paper is clean to handle and no objectionable by-products are generated during its use. Although some heat sensitive papers are quite easily marked in casual handling, most papers of



### Dale R. Davis

Dale Davis is a chemist responsible for R&D and production of electrosensitive paper. He has been with HP since 1963 and has done research on photoconductive materials with the hpa division.

Dale has a BA in Chemistry from Central Washington State College, 1959 and did research on non-silver halide photographic systems and zinc sulfide electroluminescence before joining HP. He is a member of the American Chemical Society.



### Charles K. Michener

Chuck Michener received both his Bachelor of Science and Master of Science degrees in Mechanical Engineering from California Institute of Technology. He joined the Hewlett-Packard Moseley Division (now the San Diego Division) immediately after receiving his MS in 1966. Since then, Chuck has been involved in mechanical design of recorder servo drives and is presently project leader of a group developing new strip chart recorders.

Chuck is a member of Sigma Xi.

this type do not mark easily with pressures normally encountered.

When marking at low speeds, if low stylus temperature is used to prevent image spreading, then no marks or only very light marks are made when marking at high speeds. Some recorder systems compensate for this effect by varying the stylus temperature with stylus speed.

Heat sensitive papers are commonly used in industrial and medical instruments where environmental conditions are not severe and where rapid start up is of prime importance.

A less common type of heat sensitive paper is based upon a chemical reaction between two colorless, heat sensitive materials in the coating that forms a third colored material.

This system is not pressure sensitive, but is less efficient (i.e. more energy is required to mark a given area) which limits the writing rate. Some of these papers lack long term stability, gradually turning dark. Others of these papers give off an unpleasant odor when marked.

These papers are particularly suited to those applications where the range of writing speeds is not great, where the writing rate is below 2 in/s, where rapid start-up is important, where the record will be handled a great deal, and where the record is not needed longer than about 6 months.

### Photographic Systems

One of the oldest graphic recording systems uses pho-

## SPECIFICATIONS

### HP Model 7100 Series 10" Strip-Chart Recorders

**RESPONSE TIME:** One-half second for full scale (0.6 s for 50 Hz operation).

**CHART CAPACITY:** 100 ft. chart rolls 11 in. wide with 10 in. (250 mm) calibrated writing width.

**CHART SPEEDS:** Models 7100B, 7101B: 1, 2 in/h; 0.1, 0.2, 0.5, 1, 2 in/min; 0.1, 0.2, 0.5, 1, 2 in/s. Metric models: 2.5, 5, 15, 30 cm/h; 1.25, 2.5, 5, 15, 30 cm/min; 1.25, 2.5, 5 cm/s. Models 7127A, 7128A: ¼, ½, 1, 2 in/min.

**POWER:** 115 or 230 V ±10%, 60 Hz, 65 volt-amperes for 7100B, 7128A, 42 volt-amperes for Models 7101B, 7127A, 115 or 230 V, 50 Hz models available.

**WEIGHT:** 7100B, 7128A: net 22 lbs (9.9 kg), shipping 30 lbs (13.5 kg); 7101B, 7127A: net 21 lbs (9.45 kg), shipping 28 lbs (12.6 kg).  
All weights less input modules.

**PRICES:** (Basic frame, less input module)  
Dual channel models 7100B (standard);  
7100BR (standard rack), 7100BM (metric),  
7100BMR (metric rack): **\$1300**.  
7128A (standard, bench or rack): **\$1150**  
Single channel models 7101B (standard),  
7101BR (standard rack), 7101BM (metric),  
7101BMR (metric rack): **\$1000**.  
7127A (standard, bench or rack): **\$850**

**NOTE:** Models 7100B, 7128A frame requires two input modules;  
Models 7101B, 7127A frame requires one input module.

#### OPTIONS:

Electro sensitive writing: add \$75  
With left mounted event marker (elec.): add \$35  
With two event markers (elec.): add \$70

### INPUT MODULES

For use with 7100 Series Basic Frames

#### 17500A

The 17500A has ten calibrated spans from 5 mV to 100 V full scale.

**PRICE:** Model 17500A: **\$250**.

#### 17501A

This multiple span plug-in has sixteen spans from 1 mV to 100 V full scale.

**PRICE:** Model 17501A: **\$350**.

#### 17502A

Temperature measuring input module with single span selected to match thermocouple. Built in compensation junction. The module converts input to a linear function of temperature.

**PRICE:** Model 17502A (single span, T-C match): **\$250**.

#### 17503A

The 17503A plug-in is equipped with special circuitry for gas chromatography use. A single span of one millivolt full scale is provided with potentiometric input. A high performance input filter allows the recording of signals with differential noise. Line frequency interference rejection: 100 dB.

**PRICE:** Model 17503A: **\$250**.

#### 17504A

Single span plug-in module. Single span from 5 mV to 100 V full scale. Removal of jumper wire allows potentiometric input on four most sensitive range cards (5 mV to 200 mV) with essentially zero current drain at null.

**PRICE:** Model 17504A (with one range card): **\$200**.  
(specify range card)  
Additional range card: \$25.

### HP Model 680/680M 5" Strip Chart Recorder

#### RECORDING MECHANISM:

**ELECTROSENSITIVE:** Similar to ink mechanism except a stylus for electrosensitive paper and the associated electronics are furnished in place of the ink pen.

#### CHART REQUIREMENTS:

**ELECTROSENSITIVE:** 6 in by 80 ft roll charts, 5 in (12 cm) writing width.

**RESPONSE TIME:** One-half second full scale.

**CHART SPEEDS:** 1, 2, 4, 8 in/min; 1, 2, 4, 8 in/h. Metric model: 2.5, 5, 10, 20 cm/min; 2.5, 5, 10, 20 cm/h.

**SPANS:** 5, 10, 50, 100, and 500 mV; 1, 5, 10, 50, and 100 V, full scale. Metric model has spans of 6, 12, 60, 120, and 600 mV; 1.2, 6, 12, 60, and 120 V.

**INPUT RESISTANCE:** 200,000 Ω/V (166,666 Ω/V on metric models) full scale, through 10 V span; 2 MΩ on all others. Constant 100,000 Ω input resistance on all spans available at extra cost on both models.

**STANDARDIZATION:** Continuous electronic reference from zener diode controlled power supply.

**ZERO SET:** Continuously adjustable over full recorder span.

**ACCURACY:** Better than 0.2% of full scale. Resetability: 0.1% of full scale.

**INTERFERENCE REJECTION:** DC common mode rejection better than 100 dB on 5 mV span.

**POWER REQUIREMENTS:** 115/230 V, 60 Hz, 22 VA. Optional 50 Hz models available.

**PHYSICAL DIMENSIONS:** 6½ in (1.65 mm) high, 8¾ in (219 mm) deep, 7¾ in (197 mm) wide. Rack mounting requires 7 in of vertical space.

**WEIGHT:** Net approx. 11 lbs (5 kg); shipping 17 lbs (7.6 kg).

**PRICES:**  
Models 680 (standard) or 680M (metric): **\$750**.

#### OPTIONS:

Electrosensitive writing: add \$75.  
Electric writing event marker: add \$35.

#### MANUFACTURING DIVISION: SAN DIEGO DIVISION

16870 West Bernardo Drive  
San Diego, California 92128

tographic paper or film written upon by light beams reflected from galvanometer-driven mirrors. These systems are available to record up to 36 channels or more and are capable of very high speeds. Their chief disadvantage is the cost of the paper and the instrumentation, and the inconvenience of processing. Accuracy of a galvanometer without feedback is limited to about 1%.

There are however some recording applications that can be done by no other technique, such as oscillographic recording up to 30 kHz. In one such system, a high intensity ultraviolet beam is focused on the paper. The

image is made visible by latensification.

Latensification is the process of producing a stable latent image on silver halide paper by exposure to a high intensity light. Further exposure to a low intensity light develops the image to make it visible.

The image formed by latensification will begin to darken in a matter of hours if left in room light. To make the record stable the paper must be 'fixed' by wet processing.

Although most oscillographic recording work is black on white, a two color paper is available.

## Low Voltage Electric Writing Recorders

ELECTRIC WRITING HAS MANY ADVANTAGES. Its records are permanent and not subject to degradation by heat, pressure or light. Recorders can be put into service immediately after long standby or storage periods. There is no dried ink problem, nor is priming necessary, and the system is reliable over long periods of unattended operation. Electric writing recorders withstand severe environmental conditions better than most other systems. Temperature, altitude and vibration can be tolerated to a greater extent due to the absence of fluids.

The new method of low voltage electric writing discussed on page 3 is available on the HP Model 7100 and the HP Model 680 Strip Chart Recorders, Fig. 1. Paper used in these instruments is made by laminating a metal foil to a paper base, and coating the metal surface with a resin film pigmented with zinc oxide. The result is a coating that is white and conductive.

Current is passed from the stylus through the zinc oxide layer into the metal, reducing the zinc oxide to free

zinc. Since zinc oxide is white and zinc is dark in color, a black on white trace results. The resin holding the zinc oxide remains essentially unchanged so the mark does not smudge when wiped.

The resistance of the area marked increases during marking, making it possible to mark the paper over a broad range of speeds without varying the power supply characteristics. Due to the reasonably high conductivity of the zinc oxide and the small amount of insulation required to hold the resin to the metal film, the unmarked film is quite conductive. This conductivity makes it possible to mark the paper with less than 30 volts.

There are two problems inherent with electrosensitive writing — odors generated during writing, and residue. With older types of electrosensitive papers, a detectable odor is generated during writing as a result of current passing through the coating and tearing that layer into small molecules. This writing process does not depend upon tearing the coating apart however, and there is

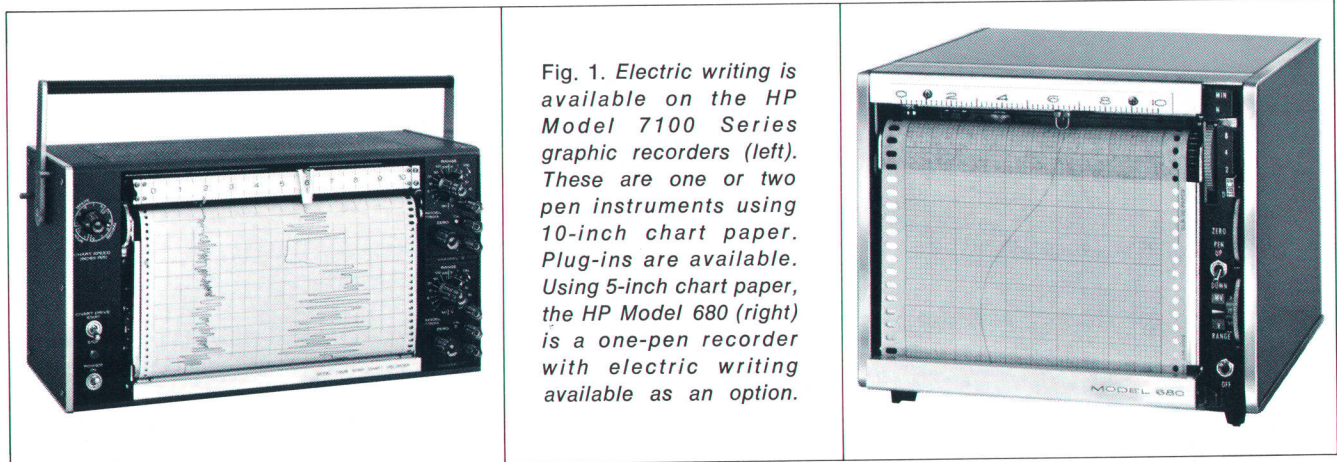

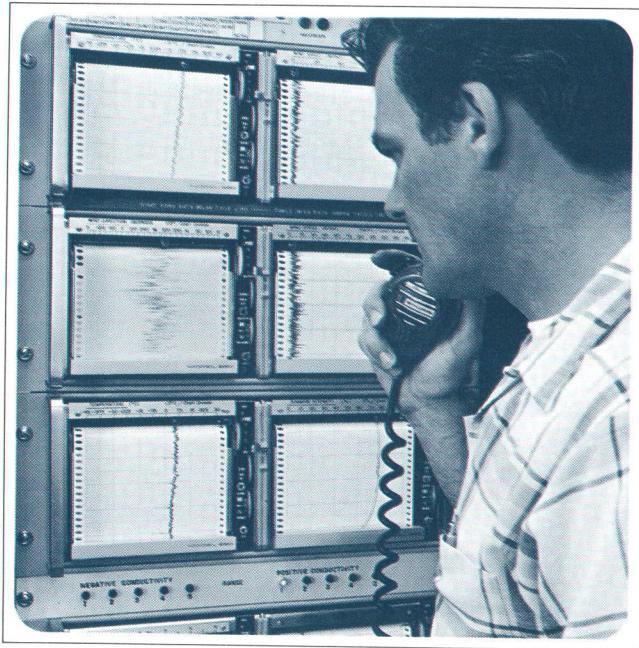

Fig. 2. This bank of recorders, being checked by Paul Eden of the National Center for Atmospheric Research, Boulder, Colorado, records meteorological data seven days a week, 24 hours a day.

considerably less odor during writing than other electro-sensitive papers currently available.

Other electro-sensitive papers depend upon the removal of a layer of white material to expose a black backing, thus generating a large amount of residue. Since the mark on the new paper depends upon the *in situ* reduction of zinc oxide, the removal of a layer is not only unnecessary but undesirable. The use of a binder that does not deteriorate during marking is of help in reducing the amount of residue generated during writing just as it reduces the odor generated during writing.

Other currently available papers can be marked with casual handling. The white layer that is removed during writing can also be removed by pressure or sometimes by moisture from the hands. The hard organic resin used in this newer type paper does not have this characteristic since the coating is harder and is coated on metal foil.

### Stylus Design

Because of the contact pressure required on the fairly abrasive electro-sensitive coating, a wear-resistant tungsten carbide stylus is used. The tungsten carbide ball initially produces a line width of 0.01 inch. It wears until the line broadens to about 0.02 inch after about 10,000 feet of travel. Then it remains fairly constant,

requiring about 12 miles of travel to produce a line 0.026 inch wide.

Unless properly designed, the stylus may break through the thin electro-sensitive coating at very slow speeds (about 1 inch per hour), and weld itself to the aluminum backing. It could plow a furrow in the coating.

This condition is avoided by mounting the tungsten carbide ball at the end of a cantilever spring (see cover picture). Should the stylus weld itself to the aluminum base, the spring bends, rocking and releasing the ball.

To assure a uniform, high-contrast line on the 10-inch chart of the HP Model 7100 Series Recorders, the stylus voltage is varied in proportion to its speed. Voltage variation is not necessary in the 5-inch Model 680, but the increased excursion and pen speed on a 10-inch chart require this refinement. As the stylus approaches a null and slows, the voltage is lowered; when the stylus is slewing rapidly, its voltage is increased.

### Typical Applications

**Meteorological Data.** Recording meteorological data requires an instrument with the capability of responding to rapid changes over a wide range. Continuous operation over long periods of time at very slow chart speeds is generally desired.

In one such application, the National Center for Atmospheric Research (NCAR), Boulder, Colorado, records ten channels of data telemetered from a remote site on the Continental Divide, Fig. 2. Data includes wind direction and velocity, positive and negative conductivity of the atmosphere, atmospheric electric field, cloud cover conditions, and temperature.

Wind direction shifts often, by about 20 to 30 degrees, and wind velocities range from zero to 145 mph. Gusts up to twice the average velocity occur frequently. Because of the slow 1 inch per hour chart speeds, ink recording would be unsatisfactory. Wide swings of the pen could saturate the paper with ink. The electric writing system, however, produces a clean, readable and dry trace.

**Radiation Monitoring.** Long periods of unattended recorder operation at very slow chart speeds are encountered in a radiation monitoring application. Gamma radiation levels from 0.01 mR/hr to 100 mR/hr are recorded by electric writing instruments operating in field environments. The instruments are subject to line voltage and frequency variations and to temperature ranges from  $-10^{\circ}\text{C}$  to  $+65^{\circ}\text{C}$ . Chart speed is 1 in/hr, making it necessary to replenish paper only about once a month. 



# Recording True-rms Voltages Over Wide Dynamic Ranges

*With this new logarithmic converter, a graphic recorder can measure ac or dc signals over four decades of amplitude without range switching. An electronic attenuator and feedback are the secrets.*

By John M. Wade

SIGNALS which vary over large amplitude ranges as functions of time, frequency, or another variable are frequently encountered in the laboratory. Amplifier and filter frequency responses are typical examples; others are sound pressure, mechanical vibrations, and some chemical and nuclear phenomena. When the relationship between one of these signals and an independent variable is to be presented graphically, it is common to use a logarithmic amplitude scale, often with the amplitudes given in dB. The log scale is usually the only way to get the whole curve on one piece of paper and still have all parts of it equally readable.

It is always an advantage, of course, if a log plot can be made quickly and automatically instead of by tedious manual plotting, especially if the plot has to be repeated to show the results of changing a parameter, or if dB values have to be calculated. This is why logarithmic converters were invented. A log

converter is an instrument which produces a voltage proportional to the logarithm of its input voltage. Connected to a standard graphic recorder, it converts linear recorder scales to logarithmic ones.

## New Log Converter

Ac or dc signals whose amplitudes vary over exceptionally wide ranges — as much as 80 dB (four decades,

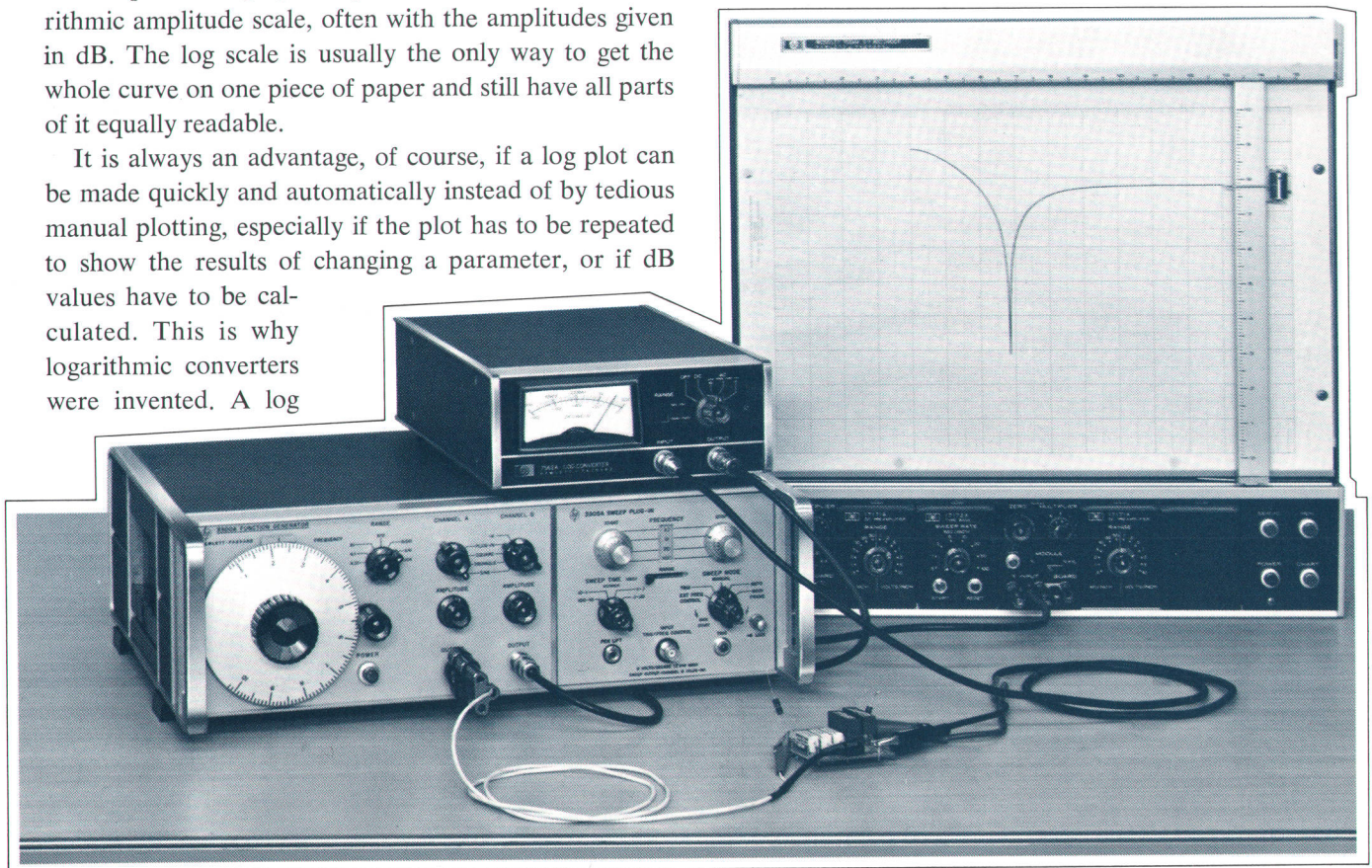

Fig. 1. New model 7562A Logarithmic Converter can be used with Model 3300A/3305A Sweep Oscillator to make frequency response plots over an 80 dB amplitude range and a four-decade frequency range. The converter produces a dc output voltage proportional to the logarithm of the rms value of an ac input signal. Its frequency range is 0.5 Hz to 100 kHz. It can also convert dc signals.

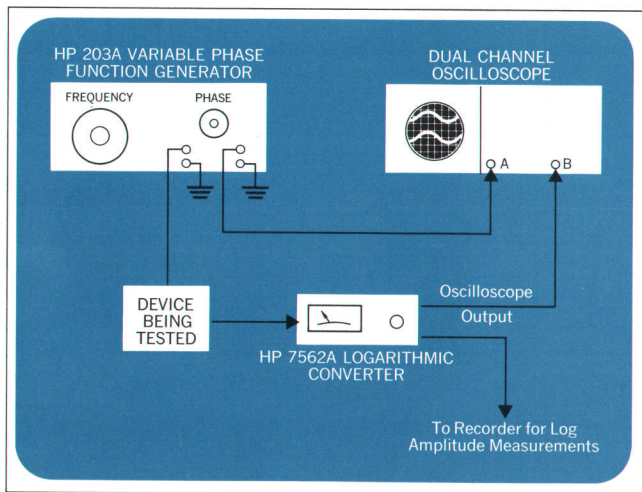
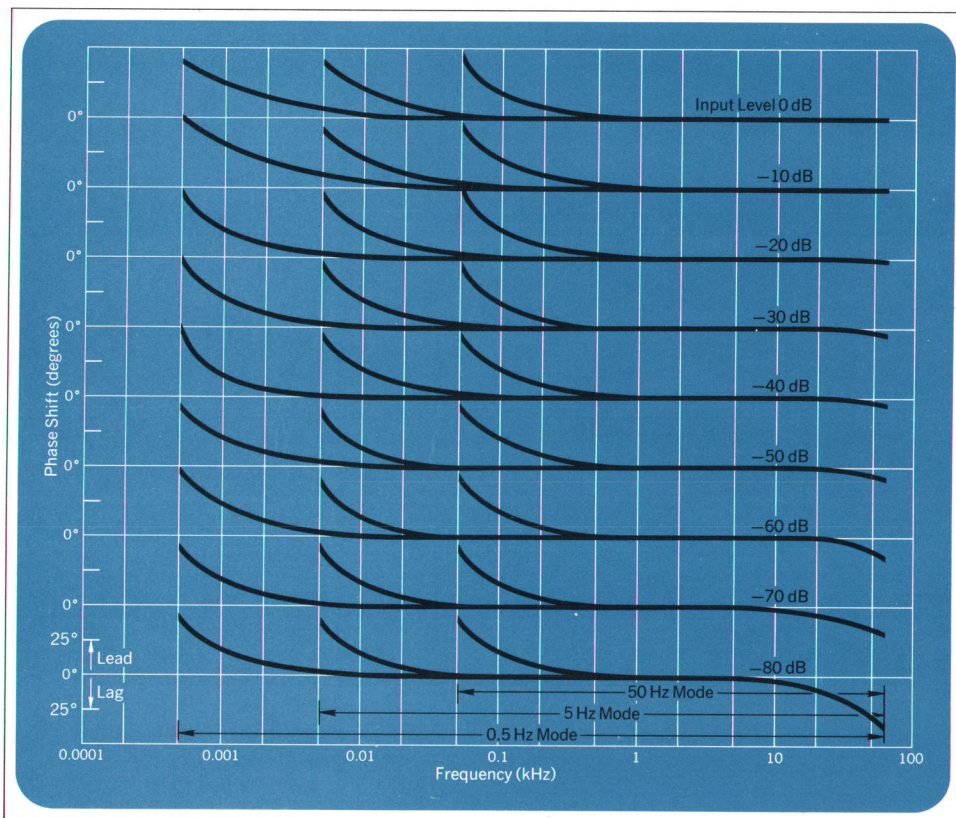

Fig. 2. The new log converter can simplify phase shift measurements by eliminating amplitude adjustments. Its oscilloscope output has the same waveform as the input signal, but has constant amplitude. To measure phase shift, the phase dial of the function generator is adjusted until the two traces align on the CRT. Phase shift is then read from the dial.

or 10,000 to 1)—can be measured using the new HP Model 7562A Logarithmic Converter. This instrument can be considered to be a log-scale ac and dc voltmeter which has a broad dynamic range. For ac input signals, it produces an output voltage proportional to the logarithm of the true-rms value of the input. Its frequency range is 0.5 Hz to 100 kHz, and its readings are accurate within  $\pm 0.5$  dB except at the ends of the frequency range, where variations may be  $\pm 1$  dB. For dc input signals, it produces an output voltage proportional to the logarithm of the input voltage, and its output is accurate within  $\pm 0.25$  dB.

In measuring non-sinusoidal ac waveforms like sound pressure or electrical noise, the type of detection is an important consideration. For the new log converter, a true-rms detector was chosen because of the mathematical significance of the rms value in noise and other non-sinusoidal measurements. We believe this is the

Fig. 3. Phase shift of Model 7562A Logarithmic Converter oscilloscope output.



first commercial log converter to have a true-rms detector.

### Frequency-Response Plotting

Using the new log converter to plot frequency responses is quite simple and is illustrated in Fig. 1. The sweep oscillator drives the device under test and the X, or log frequency, axis of the X-Y recorder. The log converter monitors the device's response and drives the Y, or log amplitude, axis of the recorder. A suitable sweep oscillator for this application is the HP Model 3300A/3305A (*Hewlett-Packard Journal*, May 1968). It sweeps the appropriate four decades and has a logarithmic sweep output signal.

### Measuring Phase Shift

Besides its recorder output, the log converter also has an oscilloscope output which can be used to observe the input signal waveform while a measurement is being made. The signal at this output has constant amplitude (about 0.5 V rms), regardless of the input voltage.

Because the oscilloscope output has constant amplitude, the log converter can simplify phase-shift measurements by eliminating amplitude adjustments. A typical setup is shown in Fig. 2. One of the outputs of a variable-phase oscillator drives the device being tested. The device's output is monitored by the log converter, and the

converter's oscilloscope output is displayed on one channel of a dual-channel oscilloscope. The other channel of the oscilloscope displays the second output of the variable-phase oscillator. To measure the unknown phase shift, the phase dial of the oscillator is adjusted until the traces align on the CRT. The phase shift is then read from the dial. In some cases the converter will introduce a small amount of phase shift (see Fig. 3). When this happens the converter's phase shift must be subtracted from the dial reading to find the unknown. No amplitude adjustments are required during the test, since the two oscilloscope traces have constant amplitudes.

### Mechanical Signals

Measuring mechanical resonances calls for a log converter which has a fairly wide dynamic range, a true-rms detector, and—this is important—extended low-frequency response. In vibration tests (see Fig. 4) the part to be tested is placed on a shake table. An accelerometer mounted on the part is monitored by the log converter and its output is recorded on magnetic tape, along with shaker frequency information. Usually the shaker frequencies are in the low audio range, with 2 to 5 Hz as their lower limit. For this reason the new log converter was designed to accept unusually low-frequency signals, down to 0.5 Hz. Of course, the lower the converter's low-frequency limit, the slower its response to amplitude changes must be. Since low-frequency response is not always a requirement, the user can speed up the converter's response at the expense of low-frequency response if he desires. Three low-frequency limits—0.5, 5, and 50 Hz—give response speeds of 1, 10, and 60 dB per second, respectively.

### 'dc' Signals

In the dc mode, the rms detector is bypassed and the log converter produces a voltage proportional to the logarithm of the instantaneous input voltage. This mode can be used, for example, to convert a linear-scale recorder to a logarithmic one. It can also be used to monitor unpredictable signals that are normally low-level but occasionally become many times their nominal values. Gas chromatographs, pulse-height analyzers, and other analytical instruments typically produce outputs like this. A log-scale recorder can be left unattended with relative certainty that transients will always remain on scale and be readable, whereas such transients would go off scale on a linear-scale recorder.

### How It Works

As the block diagram (Fig. 5) shows, the new log converter consists of a pair of logarithmic amplifiers, a dif-

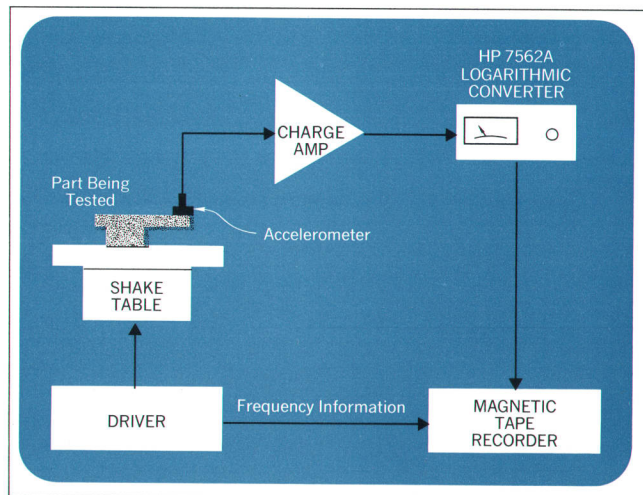

Fig. 4. In vibration tests, low-frequency limits are typically below 5 Hz. The new log converter is designed to operate down to 0.5 Hz.

ferential output amplifier, and an ac-to-dc converter containing an electronic attenuator and a thermocouple in a feedback arrangement. In the ac mode, all the elements are used: the circuit generates a direct current proportional to the rms input voltage, and this current is shaped by the logarithmic amplifiers. In the dc mode, only one logarithmic amplifier and the output amplifier are used.

Each logarithmic amplifier is an operational amplifier with a feedback transistor. The resistance of the transistor decreases as its collector current increases. Virtually all of the current flowing to the logarithmic amplifiers flows through the feedback transistors, because the operational amplifiers have field-effect-transistor input stages which draw practically no current.

The output voltage of either log amplifier is

$$V_{\text{output}} = K_1 \log I_{\text{input}} + V_k,$$

where  $K_1$  and  $V_k$  are constants and  $I_{\text{input}} = V_{\text{input}}/R_{\text{input}}$ . In the dc mode  $R_{\text{input}}$  is constant, and the output voltage of the log amplifier is proportional to the logarithm of the input voltage. In the ac mode,  $I_{\text{input}}$  is controlled so that it is proportional to the rms value of the ac input voltage.

### ac Mode

In the ac mode, incoming ac is attenuated electronically, amplified, and detected by the thermocouple. The thermocouple produces a dc output voltage proportional to the rms value, or heating value, of the ac signal.

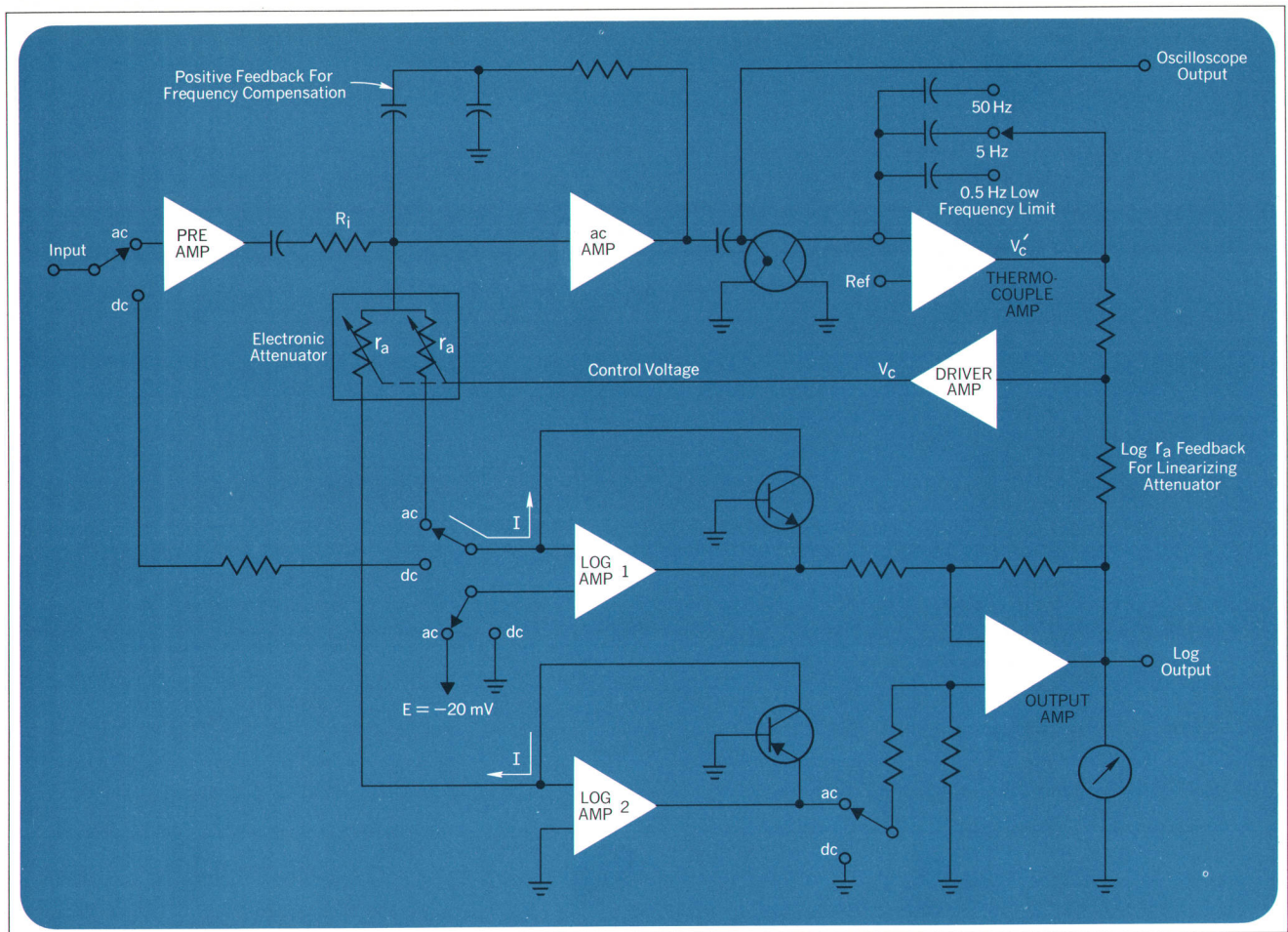

Fig. 5. In the ac mode, incoming ac signals are attenuated electronically until the dc output of the thermocouple is equal to a reference voltage. The amount of attenuation given the input signal is then inversely proportional to the rms value of the input voltage. The dc attenuator current, which is inversely proportional to the attenuation factor, goes to the logarithmic amplifiers as a measure of the rms input voltage. In the dc mode the electronic attenuator and thermocouple are bypassed.

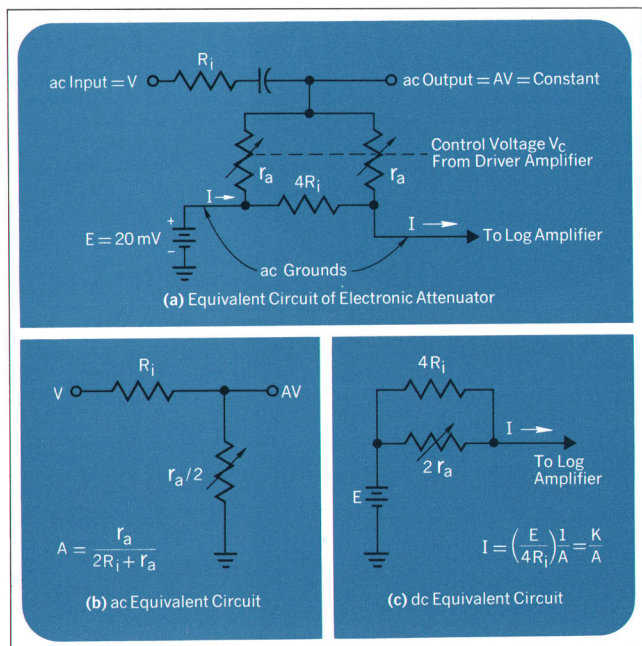

Fig. 6. The attenuator current  $I$  is inversely proportional to the attenuation factor  $A$ . Since  $AV$  is constant,  $I$  serves as a measure of the rms input voltage  $V$ .

The electronic attenuator is controlled by feedback to keep its ac output constant regardless of the input amplitude. The thermocouple amplifier compares the thermocouple output with a reference voltage. Any difference between the thermocouple output and the reference is amplified by the driver amplifier. The output voltage of the driver amplifier is fed back to the electronic attenuator as a control voltage,  $V_c$ , which adjusts the attenuator so that the attenuated ac signal always has the same rms value. This means that the amount of attenuation is inversely proportional to the rms value of the input. Therefore, measuring the amount of attenuation given the input signal is the same as measuring the rms value of the input signal. Serving as a measure of the amount of attenuation and of the rms input voltage is the direct current flowing through the electronic attenuator and through both log amplifiers. This current is controlled by the electronic attenuator so that it is inversely proportional to the attenuation factor.

The output voltage of each log amplifier has a dc component proportional to the logarithm of the direct current

flowing through it, and an ac component equal to the attenuated ac signal multiplied by the gain of the log amplifier. In the differential output amplifier, the ac components cancel and the dc components add to give a dc output voltage proportional to the logarithm of the rms value of the ac input voltage.

An important feature of the design is that the thermocouple is used only as a null-sensing device in a high-gain feedback loop. Therefore its apparent response time is much faster than its natural response time. Moreover, since its input is always the same, its nonlinearities do not affect the performance of the instrument.

### Electronic Attenuator Operation

The electronic attenuator is a resistive voltage divider whose output leg has two branches, each of which is a voltage-variable resistor. Both branches have resistance  $r_a$  (see Fig. 5). As a result of the  $-20$  mV bias voltage  $E$  on log amplifier #1, a direct current  $I$  flows out of log amplifier #2, through both branches of the electronic attenuator, and into log amplifier #1.

Fig. 6(a) shows the equivalent circuit of the electronic attenuator, as seen by one of the log amplifiers. Fig. 6(b) is the corresponding ac equivalent circuit, and Fig. 6(c) is the corresponding dc equivalent circuit. The attenuation factor  $A$  applied to ac signals is

$$A = \frac{r_a/2}{R_i + r_a/2} = \frac{r_a}{2R_i + r_a}$$

The dc input current to the log amplifier is

$$I = \frac{E}{2r_a} + \frac{E}{4R_i} = \frac{E}{4R_i} \left( \frac{2R_i + r_a}{r_a} \right) = \frac{E}{4R_i} \left( \frac{1}{A} \right) = \frac{K}{A}$$

Thus the current  $I$  is inversely proportional to the attenuation factor  $A$ , and so is directly proportional to the rms input voltage.

### FET's as Variable Resistors

Fig. 7 is a schematic diagram of the electronic attenuator. Two pairs of field-effect transistors are the variable resistors. The bias voltage ( $E$  in Figs. 5 and 6) is quite low —  $20$  mV — so the FET's operate in the linear regions of their  $V$ - $I$  characteristics, and therefore look like resistors. The resistance of each branch varies from about  $30 \Omega$  to  $1$  M $\Omega$ .

The direct current flowing through the FET's ( $I$  in Figs. 5 and 6) is an accurate measure of the rms value of the ac input signal, provided that the resistances of both branches of the electronic attenuator are equal (these resistances are labeled  $r_a$  in Figs. 5 and 6). To this end, the FET's in each pair are matched. However, it is impossible to match a pair of FET's so that they track each

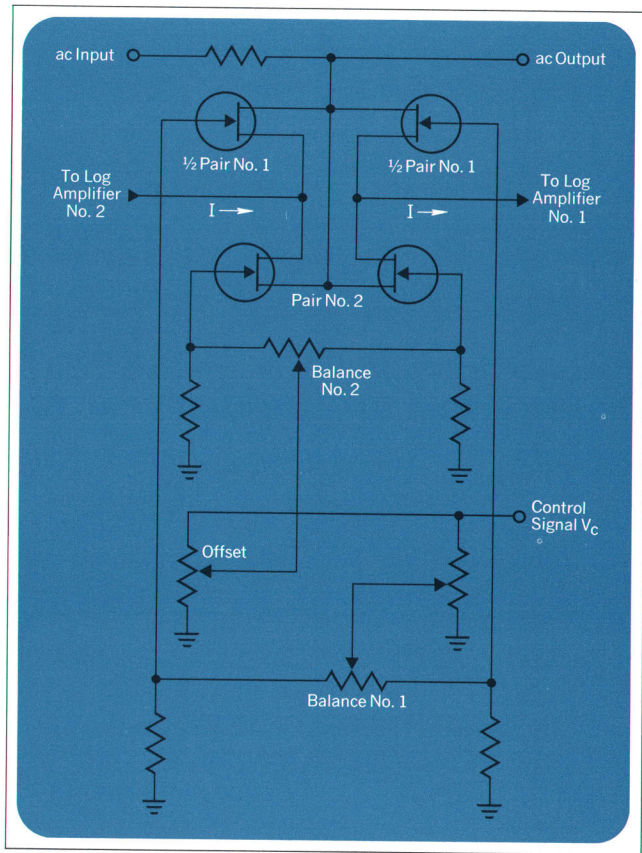

Fig. 7. Using field-effect transistors as variable resistors, the electronic attenuator can vary its resistance over more than an 80 dB range, from about  $30 \Omega$  to  $1$  M $\Omega$ , in response to a control voltage.

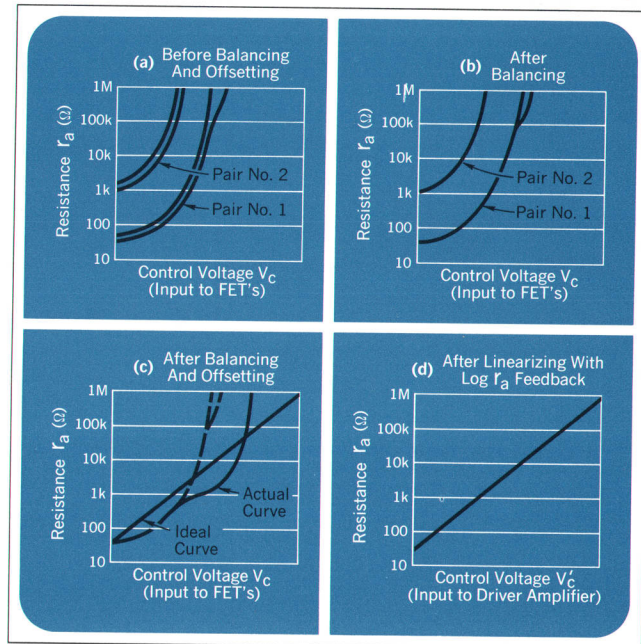

Fig. 8. Each pair of FET's in the electronic attenuator is matched over part of the resistance range. Feedback is used to linearize the resulting attenuator curve.

other exactly over such a large resistance range. The question is, how well must they track to keep the output error from being too large?

A worst-case analysis has been made, and the results show that a 10% mismatch in the resistances of the two branches of the attenuator causes only about 0.23% error in the output current! This is important, for it means that physically realizable tracking mismatches do not cause serious measurement errors.

The reason for using two pairs of FET's instead of one pair is, again, the difficulty of matching a single pair of them over the entire resistance range. Each pair is matched over part of the resistance range, as shown in Fig. 8. The curves of Fig. 8 are plots of the logarithm of the resistance of one arm of the electronic attenuator ( $\log r_a$ ) as a function of the control voltage  $V_c$  coming out of the driver amplifier.

#### More Feedback Linearizes Attenuator

Fig. 8(c) compares a typical  $\log r_a$ -vs- $V_c$  curve with the ideal curve, which is a straight line. The transfer characteristic, or 'gain' of the attenuator is the slope of the actual curve, and it varies considerably over the resistance range. For loop stability and uniform response time the slope should be constant, as it is for the ideal curve.

To linearize the electronic attenuator, additional feedback is used. The output voltage of the output amplifier is proportional to  $\log r_a$ . This signal is fed back to the summing point of the driver amplifier to force  $\log r_a$  to be a linear function of  $V_c$ , the input to the driver amplifier, as shown in Fig. 8(d). Thus the gain of the driver-amplifier/attenuator combination is constant and the time response is uniform over the 80 dB dynamic range.



#### John M. Wade

John Wade is a group leader for laboratory X-Y plotters and accessory instruments with HP's San Diego Division (formerly Moseley Division). He has been designing recorders and related instruments since he joined HP in 1961. He has worked on line followers, a keyboard, recorder time bases, recorders, and plotting systems, and has designed three logarithmic converters including the 7562A. He has a patent pending on the electronic attenuator used in the 7562A. John received his B.S. degree in engineering from UCLA in 1961. In his spare time he likes to restore antique automobiles.

fier/attenuator combination is constant and the time response is uniform over the 80 dB dynamic range.

#### Acknowledgments

The product design of the HP Model 7562A Logarithmic Converter was done by Hendrik J. Swart. Layout and circuit board design were done by David C. Hoff. Daniel J. Davitt designed the power supply and was responsible for component specification, selection, and procurement. Henry P. Tardif did the breadboarding and testing. 

### SPECIFICATIONS

#### HP MODEL 7562A LOGARITHMIC CONVERTER

##### ac and dc Modes

##### INPUT:

DYNAMIC RANGE: 80 dB.  
VOLTAGE RANGE: 1 mV to 10 V or 10 mV to 100 V selectable by front panel switch. Accepts either ac or positive dc signals.

##### OUTPUT:

VOLTAGE: 0 to 800 mV dc corresponding to 10 mV/dB.  
OUTPUT IMPEDANCE: 100  $\Omega$ .  
METER ACCURACY: Reading accurate to  $\pm 1$  dB, referred to output.

##### dc Mode

##### RISE TIME:

Signal Level	Maximum Rise Time	
	1 mV-10 V Range	10 mV-100 V Range
1 mV- 10 mV	400 $\mu$ s	—
10 mV-100 mV	40 $\mu$ s	400 $\mu$ s
100 mV- 1 V	4 $\mu$ s	40 $\mu$ s
1 V- 10 V	2 $\mu$ s	4 $\mu$ s
10 V-100 V	—	2 $\mu$ s

INPUT IMPEDANCE: 100 k  $\Omega$  shunted by less than 100 pF single ended.

ACCURACY:  $\pm 0.25$  dB at 25°C.

TEMPERATURE COEFFICIENT:  $\pm 0.02$  dB/°C maximum.

##### ac Mode

INPUT IMPEDANCE: 1 M  $\Omega$  shunted by less than 100 pF single ended.

ACCURACY AND FREQUENCY RESPONSE: (at 25°C).

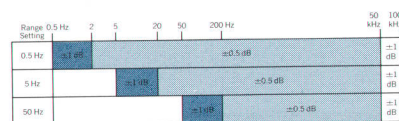

TEMPERATURE COEFFICIENT:  $\pm 0.04$  dB/°C maximum.

##### SLEWING SPEED:

Range Setting	Minimum Slewing Speed
0.5 Hz	1 dB/s
5 Hz	10 dB/s
50 Hz	60 dB/s

OSCILLOSCOPE OUTPUT: Approximately 0.5 V rms regardless of input, maintaining input signal waveform suitable for monitoring with oscilloscope.

DETECTION: True rms.

CREST FACTOR: 5 to 1 except where limited by maximum input voltage.

MAXIMUM PEAK INPUT VOLTAGE:  $\pm 25$  V on 1 mV to 10 V range;  $\pm 250$  V on 1 mV to 100 V range.

##### General

OPERATING TEMPERATURE: 10°C to 40°C.

WARM-UP TIME: 20 minutes nominal.

POWER REQUIREMENTS: 115/230 V ac, 50/60 Hz, 40 VA.

PHYSICAL DIMENSIONS: 3 $\frac{1}{16}$  in (88 mm) high, 7 $\frac{3}{4}$  in (197 mm) wide, 11 $\frac{1}{2}$  in (292 mm) deep.

CONNECTION FACILITIES: Front and rear input and output BNC connectors.

WEIGHT: 8 lbs (3.6 kg) net.

PRICE: Model 7562A, \$995.

MANUFACTURING DIVISION: HP SAN DIEGO DIVISION  
16870 West Bernardo Drive  
San Diego, California 92128

THE ATOMIC HYDROGEN MASER is the most stable type of frequency source known. Its short-term stability, or spectral purity, is excellent. In long-term measurements, its frequency uncertainty is less than one part in  $10^{14}$ , which corresponds to a time uncertainty of one second in three million years.

However, despite its high stability, the hydrogen maser has not yet proved to be a practical frequency source for most applications. Invented about eight years ago, it is still at any early stage of development, and early models have been large, heavy, and costly.

Of some significance is the fact that until recently, few scientific projects required the extremely high stability of the hydrogen maser. This is now changing; new applications are being conceived in which useful results can be

properties from time-invariant atomic resonances. When the atoms change from certain energy states to certain higher or lower ones they absorb or emit energy at particular frequencies.

The hydrogen maser is an active oscillator powered by energy from the hydrogen atom. The information extracted from it is the frequency that is characteristic of the energy emitted by the atoms as they change energy states. In this respect the hydrogen maser differs from the more widely used atomic frequency sources, i.e., from cesium-team-tube-controlled oscillators and rubidium-gas-cell-controlled oscillators. In these standards, the cesium and rubidium devices are passive elements of frequency-control loops, while the actual outputs are generated by quartz oscillators.

## Atomic Hydrogen Masers

### An Introduction and Progress Report

*Size and weight are being reduced, and demand is growing for the hydrogen maser's high stability. A satellite-borne maser is being developed. Still needed is more product-oriented development.*

**By Robert F. C. Vessot**

obtained only with frequency sources that are stable within parts in  $10^{14}$ . These applications are in radio astronomy, in deep-space tracking, in super-accurate time-keeping, in navigation systems, and in tests of Einstein's theory of relativity.

Development work is continuing. Recently, prototype hydrogen masers have been built that are about half as large and half as heavy as previous versions. Further improvements are possible, and there is reason to expect that within the next few years the hydrogen maser will become a practical frequency standard for use where the highest attainable precision is needed.

#### **An Active Oscillator**

All atomic frequency standards derive their stability

The hydrogen maser shares with cesium standards the property of high intrinsic reproducibility, which means that it can be built and aligned without reference to any other standard. It can therefore serve as a primary frequency standard.

#### **Long Storage Time Means Stability**

Early in 1957, Professor Norman F. Ramsey of Harvard University and his graduate students D. Kleppner and H. M. Goldenberg were looking for ways to store atoms without perturbing their energy states. According to the Heisenberg uncertainty principle, the longer the atom takes to make a transition between energy levels, the more accurately one can determine the energy difference between the two levels and the frequency of the

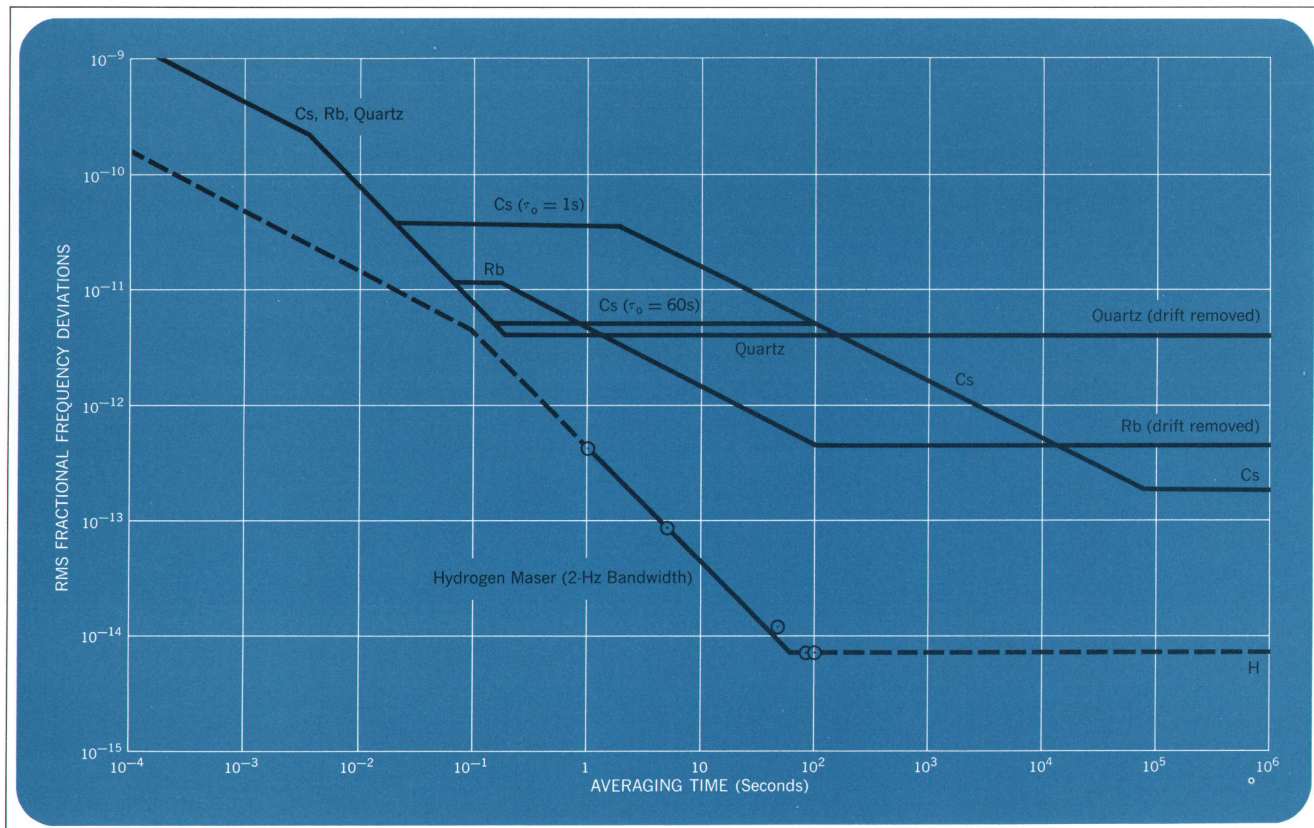

Fig. 1. The atomic hydrogen maser is the most stable oscillator known. Shown here are measured rms fractional frequency deviations as a function of averaging time. The data points represent the latest stability measurements made on hydrogen masers. For comparison, stability curves for a rubidium atomic standard, a cesium atomic standard, and a quartz oscillator are also shown.

radiated or absorbed energy. (Energy difference  $E$  equals Planck's constant,  $h$ , times frequency,  $\nu$ .) The uncertainty relation says that  $\Delta E \Delta t \geq h/4\pi$ , where  $\Delta E$  is the uncertainty in the energy associated with a particular transition and  $\Delta t$  is the time required for the transition. Since  $E = h\nu$ , the uncertainty principle means that  $\Delta \nu \geq 1/(4\pi \Delta t)$ , that is, frequency uncertainty is smaller for longer transition times.

In a cesium-beam tube,  $\Delta t$  is the time of flight of the cesium atoms through the RF cavity structure. This time is less than a millisecond for the HP Model 5061A Cesium Standard, and the resonance width is 550 Hz. In a rubidium gas cell, the storage time is a little longer; the resonance width in the HP Model 5065A Rubidium Standard is about 180 Hz.

The Harvard group discovered that hydrogen atoms could be stored in teflon-coated quartz bulbs for nearly one second! Consequently the resonance width for the hydrogen maser is less than 1 Hz. This corresponds to

an oscillator which has a Q of the order of  $10^9$ .

### How It Works

Hydrogen atoms consist of a single proton and a single electron. The proton and the electron each have angular momentum  $I = \frac{1}{2}$ . (This is shorthand notation for  $\frac{1}{2}h/2\pi$ . Angular momentum is always given in units of  $h/2\pi$ .) As a result of their charge and their angular momentum, the electron and the proton also have magnetic dipole moments. Hence they exert a torque on each other just as two bar magnets would if brought near each other. This torque causes a mutual precession of the magnetically coupled angular-momentum vectors such that the total angular momentum  $F$  is the vector sum of the two angular momenta  $I_{\text{proton}}$  and  $I_{\text{electron}}$ . The precession frequency is  $\nu_0 = 1420 \text{ MHz}^*$ .

According to the rules of quantum mechanics, the proton-electron system can exist only in configurations

\* The actual frequency is 1420.405 751 786 4 MHz.



that differ in total angular momentum by one unit of  $h/2\pi$ . Two states are possible, one with zero total angular momentum (that is,  $F = 1/2 - 1/2 = 0$ ), and one with total angular momentum  $h/2\pi$  (that is,  $F = 1/2 + 1/2 = 1$ ). The  $F = 0$  state is a lower-energy state. The difference in the energies of the two states is  $E = h\nu_0$ . When atoms change from the  $F = 1$  state to the  $F = 0$  state, they radiate energy at frequency  $\nu_0 = 1420$  MHz. This energy is the output of the hydrogen maser.

The working components of the hydrogen maser are illustrated in Fig. 2. A 100-MHz RF discharge dissociates molecular hydrogen into atomic hydrogen. The beam of atoms from the dissociator is directed through the highly inhomogeneous field of a hexapole magnet. In the magnetic field, the  $F = 1$  energy level splits into three sub-levels, labeled  $m_F = -1, 0, +1$  (see Fig. 3). Atoms in the  $F = 0$  state and atoms in the  $F = 1, m_F = -1$  state are deflected outward by the magnetic field. Atoms in the  $F = 1, m_F = 0$  and  $+1$  states are focused by the magnet and are directed into a teflon-coated quartz storage bulb located in the center of a microwave cavity. The cavity is tuned to the 1420-MHz transition frequency of the atoms. Any small magnetic disturbance which has components at or near this frequency will stimulate some of the atoms to change to the  $F = 0$  state and radiate energy. Part of this energy is stored in the cavity, part is dissipated in cavity losses, and part is coupled out. If the RF magnetic fields in the cavity stimulate enough atoms to radiate, so that the radiated power exceeds the losses, sustained maser oscillations take place.

A typical output power level from a hydrogen maser is about  $-97$  dBm, or  $2 \times 10^{-13}$  W. To provide an output at a useful frequency and power level, the maser output is generally used to

control a quartz oscillator via a phase-lock servo system. Fig. 4 shows a typical system having 100-MHz, 5-MHz, and 1-MHz outputs.

### Latest Developments

The first hydrogen maser was operated at Harvard in 1960. At Varian Associates' Beverly, Massachusetts plant, research on hydrogen masers began in 1961, supported by the Office of Naval Research and NASA's Marshall Space Flight Center. In 1964 two masers were delivered to the U.S. Naval Research Laboratory. In 1967 that part of Varian's Beverly operation which was engaged in frequency-standard work was acquired by Hewlett-Packard. Although several government-supported laboratories throughout the world are building hydrogen masers, the HP Beverly group is the only commercial group working in this field. Eleven of its masers are now in service.

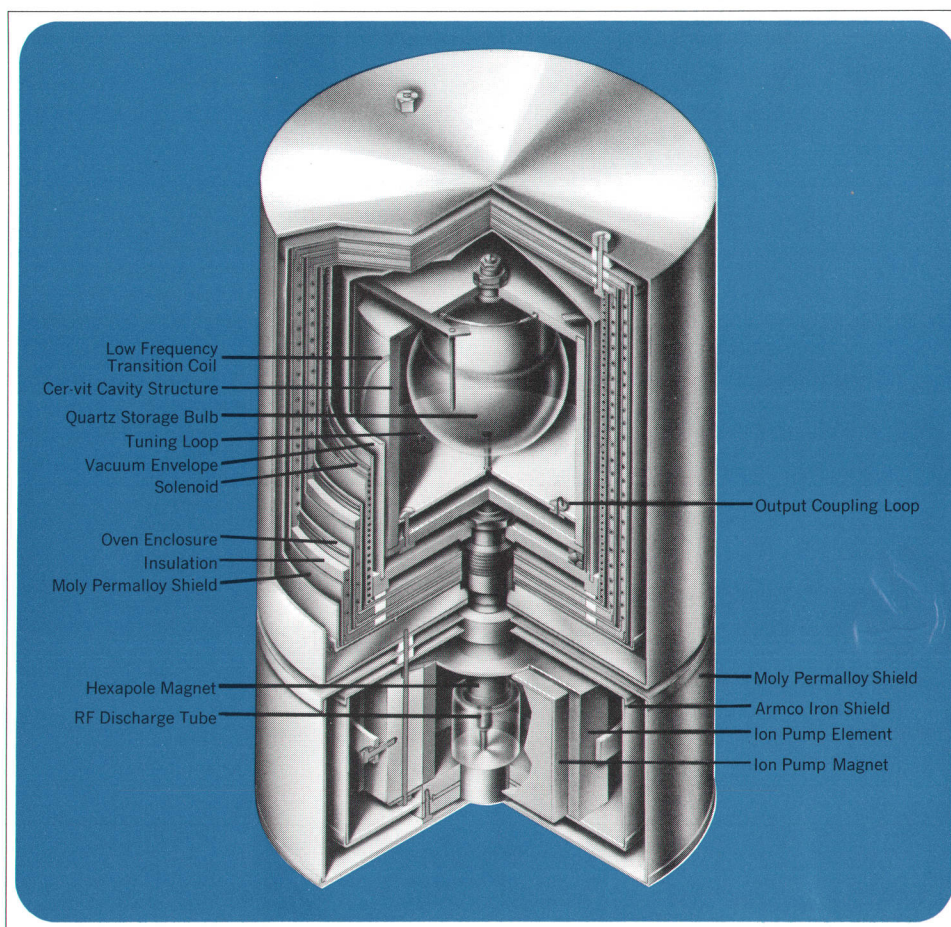

Fig. 2. In a hydrogen maser, atoms of hydrogen in certain energy states are directed magnetically into a teflon-lined quartz storage bulb inside a microwave cavity. The atoms stay in the bulb for nearly a second, some of them changing energy states and radiating energy at 1420 MHz. Maser oscillations occur when enough power is radiated by the atoms to overcome losses in the cavity.

Current efforts at Beverly are aimed at developing a satellite-borne clock consisting of two hydrogen masers for an experiment to measure the gravitational red shift

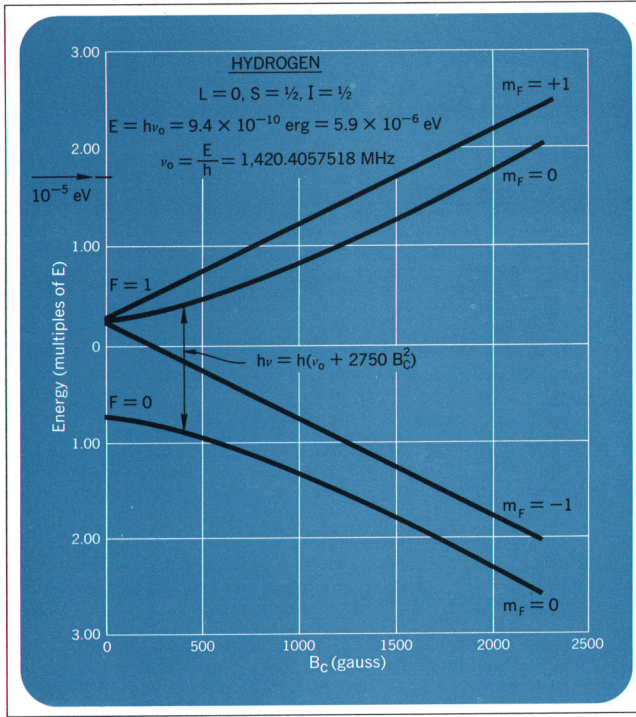

Fig. 3. In the hydrogen maser, the desired transition is from energy state  $F = 1, m_F = 0$  to energy state  $F = 0, m_F = 0$ . The energy of this transition, and therefore the maser's operating frequency  $\nu$ , depend upon the magnetic field  $B_c$ , so maser cavities are carefully shielded to eliminate stray fields.

predicted by Einstein (more about this later). A new maser has been built; it is about half the size of earlier designs. The reduction in size comes from a more compact and shorter ion pump (which removes spent hydrogen atoms and other atoms from the cavity), shorter and more efficient magnetic shields, and better use of space. This design is also much more rugged than previous designs. The table on page 20 gives some data on its performance, and Fig. 5 shows a cabinet-mounted version designed for NASA. Eventually, a new commercial version may be introduced; however, considerably more development work is needed before this will be possible.

### New Uses

Several scientific programs now under way or proposed depend upon frequency sources having the stability of hydrogen masers.

### ... Radio Astronomy

Radio interferometry is today one of the most active and forward-looking fields of science — a veritable new frontier. Long-baseline radio interferometers are being used to measure the sizes, positions, and characteristics of many different kinds of small-angle sources, including quasars, pulsars, and narrow-band OH radiation.

In a long-baseline interferometer, two antennas spaced hundreds or thousands of kilometers apart observe the same source. Their received radio-frequency signals are heterodyned down in frequency and recorded on magnetic tape. Later, the tapes from the two stations

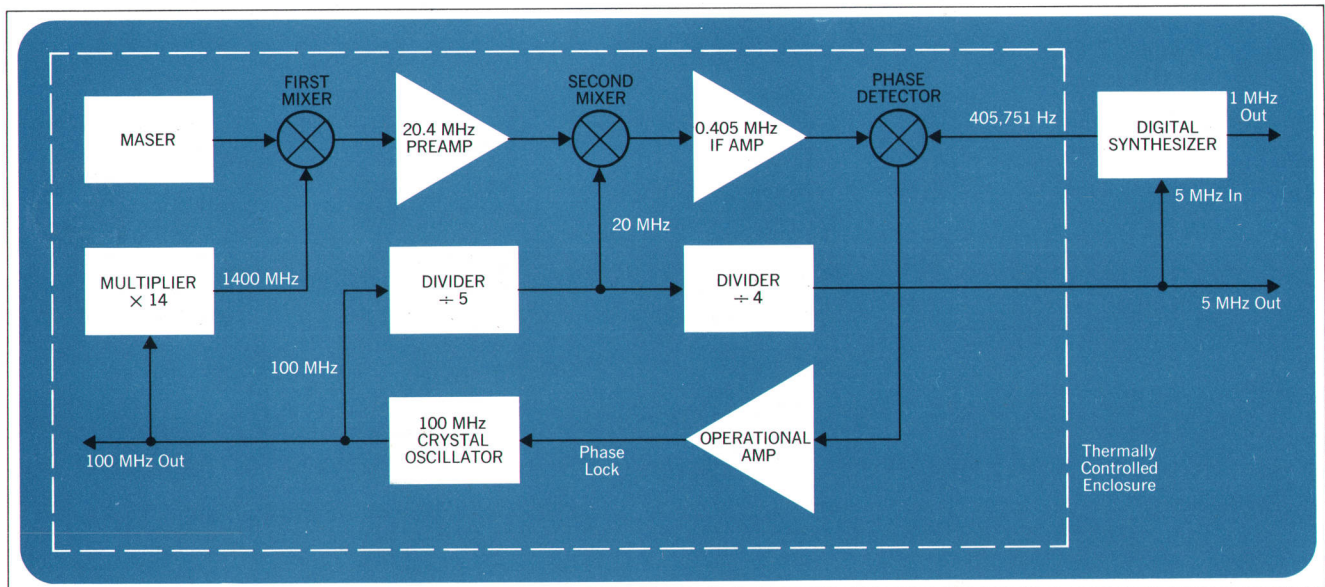

Fig. 4. The hydrogen maser's output frequency is 1420.405 751 786 4 MHz and its output power level is typically  $-97$  dBm. Here is a system for obtaining 100-MHz, 5-MHz, and 1-MHz outputs at useful power levels.



Fig. 5. The latest version of the hydrogen maser is much smaller and more rugged than previous designs. Two masers similar to this one but without cabinets will be put into orbit in a satellite to test the gravitational red shift predicted by Einstein.

are brought together and correlated by digital computer. The precision of the results depends upon the length of time over which it is possible to correlate the two signals, and this is limited by the length of time that the local oscillators at the two stations remain coherent in phase. (Separate LO's must be used because of the wide physical separation.) Several interferometers are using rubidium and cesium standards as local oscillators. Hydrogen masers are also being used in several locations, and are being considered for others because of their superior stability.

### ... Deep-Space Tracking

Very accurate doppler tracking of deep-space probes is possible when a hydrogen maser is used as a frequency source. Development work on hydrogen masers for deep-space tracking is now being done at NASA's Goddard Space Flight Center and at California Institute of Technology's Jet Propulsion Laboratory.

### ... Super-Accurate Timekeeping

The two hydrogen masers at the Naval Research Laboratory are monitored by telephone link at the U.S. Naval Observatory and serve as a 'super-clock' or 'flywheel' for comparison with the time standard at the observatory. This standard is based on a weighted average of a number of cesium-beam devices.

### ... Tests of Einstein's Theory of Relativity

Scientists of the Massachusetts Institute of Technology are engaged in two tests of relativity theory, using the radar and radio telescope at Lincoln Laboratory's Haystack Microwave Research Facility at Tyngsboro, Massachusetts (Fig. 6). In one test, radar pulses are being used to track Venus and Mercury as these planets pass behind the sun. According to Einstein's predictions, the transmission times of the pulses will be increased by about  $130 \mu\text{s}$  (in a round-trip travel time of 25 minutes) as the energy just grazes the sun. A hydrogen maser controls the clock that times the pulses.

In the second experiment, the separation between two quasars will be monitored as radiation from one of them passes near the sun. Quasars are good approximations to point sources of energy. The relativistic effect to be measured is the predicted deflection of the energy as it



### Robert F. C. Vessot

Bob Vessot received his B.S., M.S., and Ph.D. degrees in physics from McGill University in 1951, 1954, and 1957. From 1956 to 1960 he was a staff member at the Massachusetts Institute of Technology, where he worked on cesium-beam frequency standards and a cold-helium-gas-moderated cesium maser. In 1960, he joined the Beverly group (then Varian Associates, now HP) and initiated a program concerned with the

newly invented atomic hydrogen maser. He is now manager of maser development. Along with N. F. Ramsey and D. Kleppner, Bob is a co-investigator in the gravitational red shift experiment in which a hydrogen-maser clock will be placed in orbit to check Einstein's theory of relativity.

An avid skier and sailor (ocean racing), Bob is also interested in old clocks and organs. He is vice president of the Marblehead Arts Association and is in charge of restoration of the association's 18th century mansion. He is a member of the Canadian Association of Physics and the American Physical Society. He has published numerous papers, chiefly on hydrogen masers and related subjects.

passes near the limb of the sun. The predicted maximum deflection is 1.75 seconds of arc. To increase the accuracy of the experiment, interferometric techniques will be used; two widely separated passive antennas will receive the signals and the phase differences between the two received signals will be measured to determine the direction from which the energy appears to come. The initial attempt to perform this experiment is planned for late 1968. Working with Lincoln Laboratory's Haystack site will be the National Radio Astronomy Ob-

servatory at Green Bank, West Virginia. Both Green Bank and Haystack will use hydrogen masers.

### ... The Red Shift Experiment

Another test of relativity theory is being undertaken jointly by NASA, Harvard, MIT and HP. This is an experiment to measure the effect of gravitation on time by placing into synchronous orbit a clock system consisting of two hydrogen masers. The rate of this clock will then be compared with the rate of a similar clock on the ground.

According to relativity theory, the relative rates of two clocks, each operating in its proper inertial frame, will be different if the clocks are at different gravitational potentials. Again according to Einstein, a photon having energy  $E$  has an equivalent mass ' $M$ '  $= E/c^2 = h\nu/c^2$ . The gravitational potential acting on this 'mass' will result in the photon's having greater energy at higher gravitational potential. Because  $E = h\nu$ , a difference in energy corresponds to a difference in frequency; the fractional change of frequency is  $\Delta\nu/\nu = \Delta\phi/c^2$  where  $\Delta\phi$  is the change in gravitational potential and  $c$  is the velocity of light.

Relativity predicts that because of the gravitational shift and other orbital effects, the clock in orbit will run faster than the ground-based clock by 46.5  $\mu$ s per day. If this turns out to be so, an important aspect of relativity theory will be confirmed. With a clock precision of one part in  $10^{13}$ , the gravitational shift can be measured to within  $\pm 0.02\%$ .

HP is actively involved in planning and directing this experiment, as well as in developing the hydrogen masers for it. 

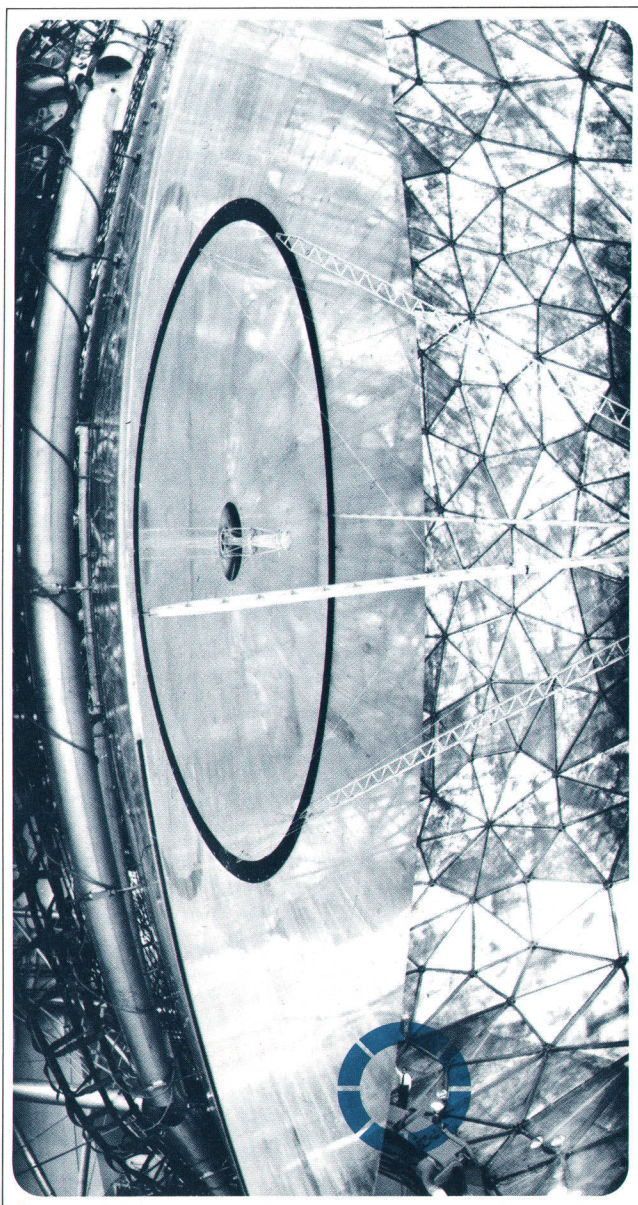

Fig. 6. The 120-foot antenna at Lincoln Laboratory's Haystack Microwave Research Facility. Notice the man at the bottom. Haystack is one of several radar and radio astronomy facilities which use hydrogen masers as frequency standards.

### Performance Data—Hydrogen Maser

<b>Frequency:*</b>	1,420,405,751.7864 Hz*
<b>Frequency</b>	
<b>Resettability:</b>	Better than 1 part in $10^{12}$
<b>Frequency Stability:</b>	
<i>Averaging Interval</i>	<i>Stability</i>
1 second	$4 \times 10^{-13}$
100 seconds	$7 \times 10^{-15}$
1 hour	$7 \times 10^{-15}$
<b>Output Level:</b>	-97 dBm
<b>Power Input:</b>	105 to 125 volts, 50/60 Hz
	150 watts
<b>Size:</b>	42 inches high
	21 inches wide
	26 inches deep
<b>Weight:</b>	600 lbs

\* This is the transition frequency for a free, stationary atom in zero magnetic field. The actual maser frequency differs from this due to wall shift, second-order doppler effect, and magnetic field. Corrections for these effects are easily applied.